

## GLENWOOD™ INSTALLATION INSTRUCTIONS



Ensure that personnel carrying out this installation have the relevant qualifications/certificates. Ensure that all relevant personnel read the points listed within this leaflet and that a copy is given to staff involved with the installation and maintenance of this product. Please refer to 'The Manual Handling Operations Regulations 1992'. Glasdon recommends that a full Health and Safety analysis is carried out prior to installation.

### EQUIPMENT REQUIRED

Spade / Tape Measure / Spirit Level / Hand Saw (required for heights above ground of 830mm or lower)  
 Relevant Safety Equipment (gloves, reflective clothing, etc)  
 If concreting into the ground we recommend using a quick setting concrete i.e. QC10.

For the majority of applications installing the Glenwood by backfilling is adequate. However, for areas where soil quality is particularly poor the Glenwood can be installed using a dry concrete mix.

### HEIGHT OPTIONS

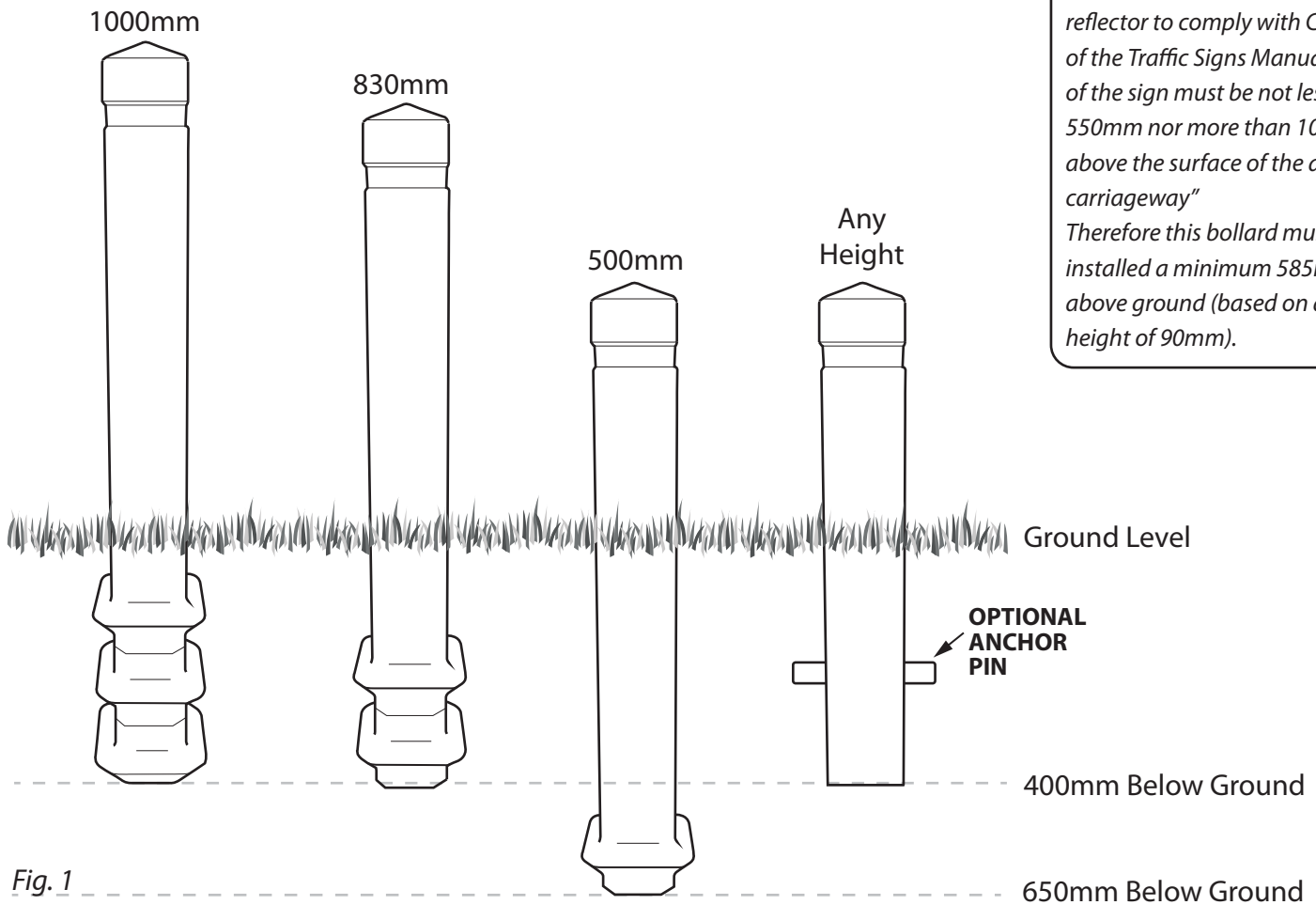

*Please note that in order for the reflector to comply with Chapter 4 of the Traffic Signs Manual "the top of the sign must be not less than 550mm nor more than 1000mm above the surface of the adjacent carriageway" Therefore this bollard must be installed a minimum 585mm above ground (based on a kerb height of 90mm).*

Fig. 1

The standard bollard is 1000mm above ground. However a height of 830mm and 500mm can be achieved without the need to excavate a deeper hole (see Figure 2 and 3 for details).

### OPTIONAL ANCHOR PIN

An anchor pin can be used to achieve any other height. Decide on the height of the bollard required and add this to the depth below ground (the depth of the bollard can vary depending on the height but we recommend at least 400mm of the bollard should be located below the ground to give adequate anchorage). Measure and mark the bollard then cut the remaining section off the base using a hand saw. Drill a 32mm diameter hole on each side of the bollard approximately 70mm from the base (ensure the holes are central). Insert the anchor pin through both drilled holes. This will give anchorage into the ground to prevent the bollard from easily lifting out of the ground. Follow Figure 4 onwards for installation instructions.

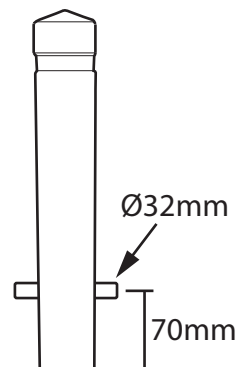

500mm Above  
Ground

830mm Above  
Ground

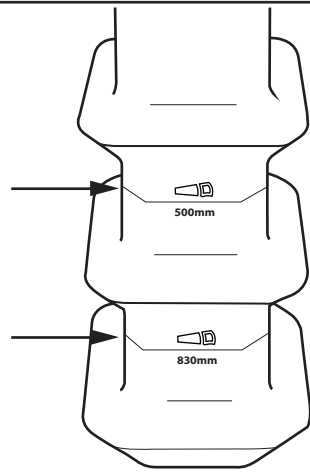

Fig. 2

The bollard has two moulded-in saw grooves at the base.

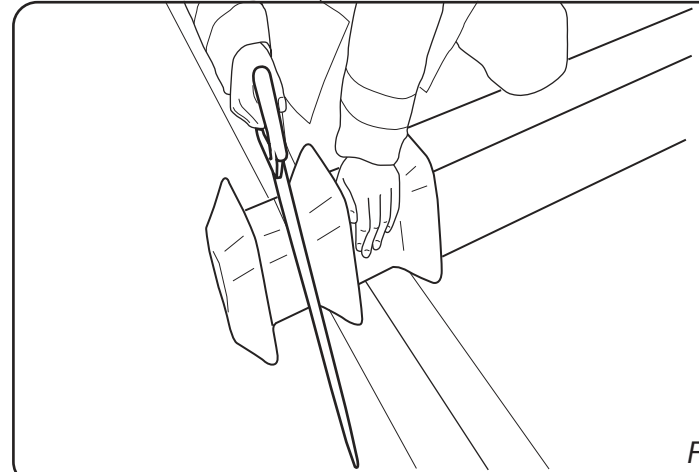

Fig. 3

For a height above ground of 500mm or 830mm, cut off the section of the bollard marked with the corresponding height measurement. Use a hand saw and use the moulded-in saw grooves as a guide.

MINIMUM HOLE DIMENSIONS

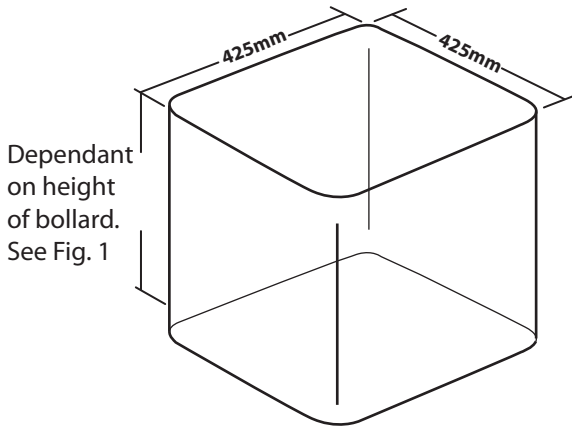

Fig. 4

Remove any top dressing (turf etc) if required and excavate a hole approximately 425mm x 425mm. Refer to Fig.1 for depth (take care to avoid underground services).

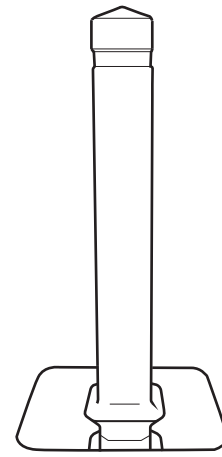

Fig. 5

Tamp the bollard in place (remove/refill soil as required to ensure the correct height above ground is achieved).

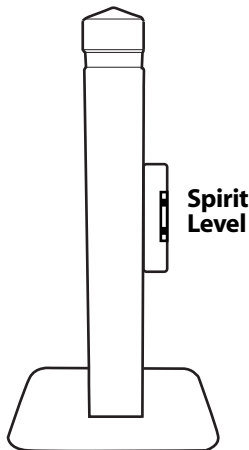

Fig. 6

Backfill the hole with soil ensuring the bollard remains vertically level using a spirit level.



Fig. 7

If required replace the turf/ bark/ top dressing as appropriate.

**IMPORTANT NOTE:** PLEASE ENSURE THAT ALL RELEVANT PERSONNEL READ THE POINTS LISTED WITHIN THIS LEAFLET AND THAT A COPY IS GIVEN TO STAFF INVOLVED WITH THE INSTALLATION AND MAINTENANCE OF THIS PRODUCT.

**SAFETY NOTE:** PLEASE REFER TO 'THE MANUAL HANDLING OPERATIONS REGULATIONS 1992' DURING HANDLING.

 **Glasdon** AND GLENWOOD™ BOLLARD ARE TRADEMARKS OR REGISTERED TRADEMARKS OF GLASDON GROUP OR ITS SUBSIDIARIES IN THE U.K AND OTHER COUNTRIES

- A planned maintenance schedule or regular inspection is recommended, replacing components as necessary.
- Replacement components are available direct from GLASDON.
- GLASDON cannot be held responsible for claims arising from incorrect installation, unauthorised modifications or misuse of the product.

Issue 1 Nov 2012 Stock no. C000/0435  
© Copyright 2012

Glasdon UK Ltd reserve the right to alter specifications without prior notice.



**Glasdon U.K Limited**  
Preston New Road  
BLACKPOOL  
Lancashire FY4 4UL  
Tel: 01253 600410  
Fax: 01253 792558  
email: sales@glasdon-uk.co.uk  
web: www.glasdon.com